

\*NOTE:  
TOP OF POST  
FLUSH WITH TOP  
OF PICKET. POST  
CAP ADDITIONAL  
INCH TO HEIGHT.

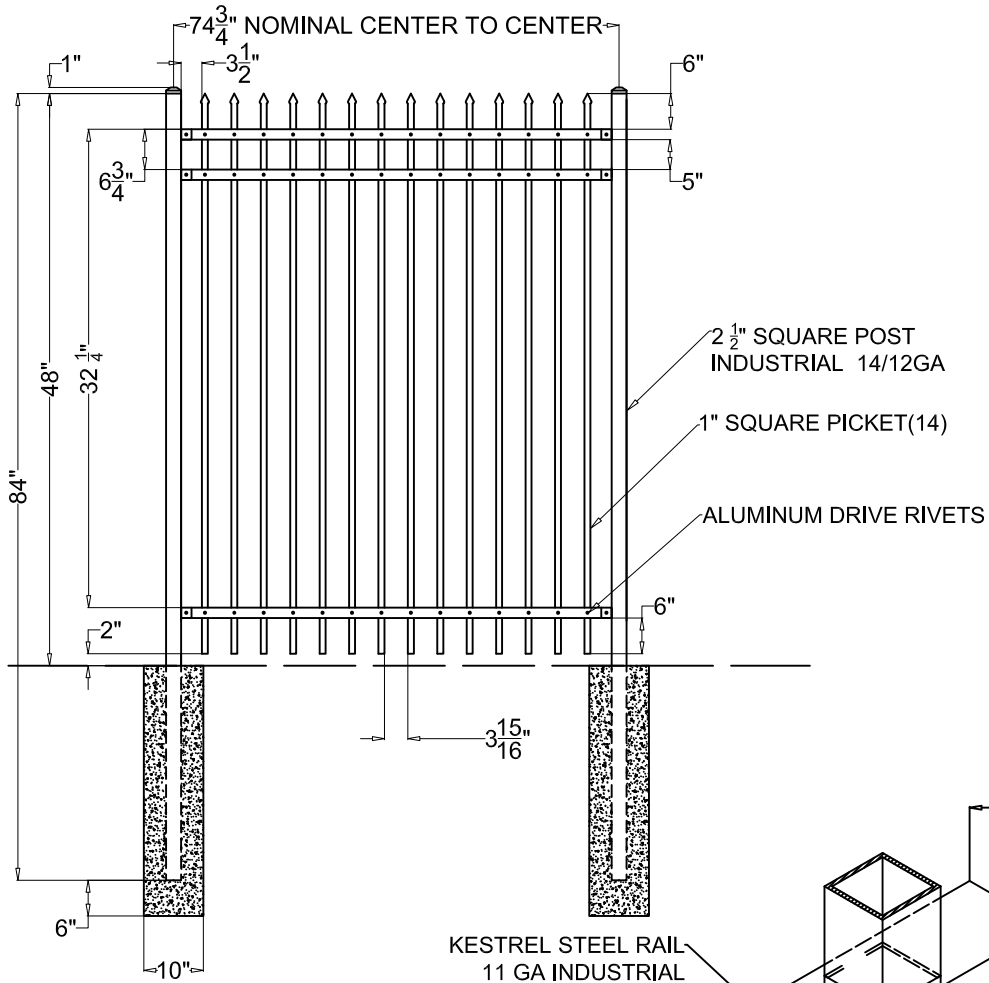
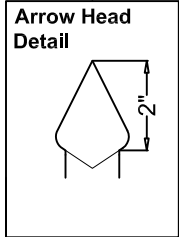

**OPTIONS:**

**Fence Heights:**

- 4 ft
- 5 ft
- 6 ft
- 7 ft
- 8 ft

**Picket Gauge:**

- 18 GAUGE
- 16 GAUGE
- 14 GAUGE

**Cap Style:**

- Ball Style
- Flat Style

**Color:**

- Black
- Brown
- White
- Green

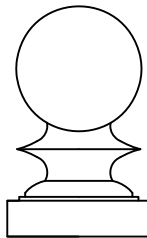

BALL  
STYLE  
CAP

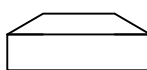

FLAT  
STYLE  
CAP

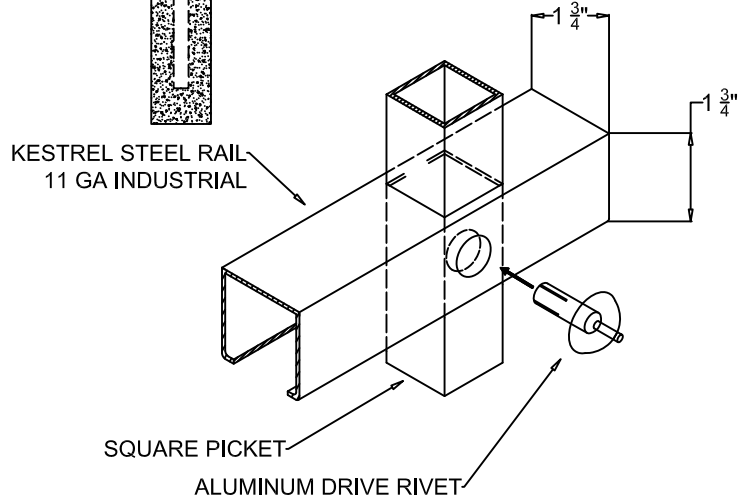

**BRACKET DETAIL:**

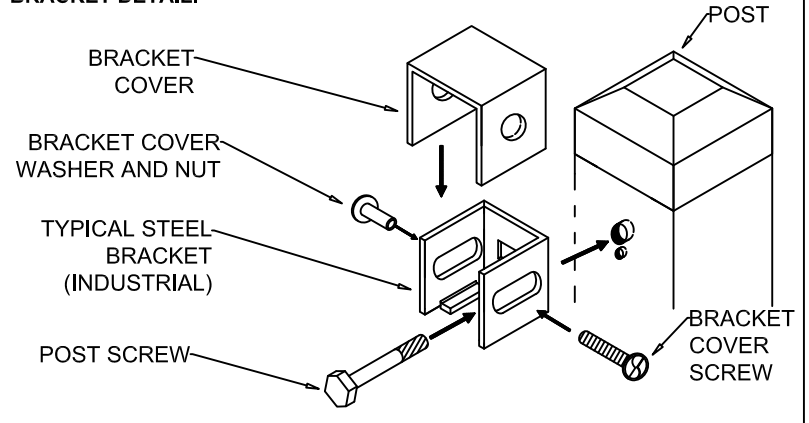

**Kestrel 6' Section  
Industrial 4' Height**

**NATIONAL FENCE SYSTEMS, INC.**

1033 Route 1  
Avenel, NJ 07001  
1-800-211-2444

www.nationalfencesystems.com

Installer:

Project:

DWG NO:  
KSI.FS6.4

DR: es

