

*NOTE:
TOP OF POST
FLUSH WITH TOP
OF PICKET. POST
CAP ADDITIONAL
INCH TO HEIGHT.

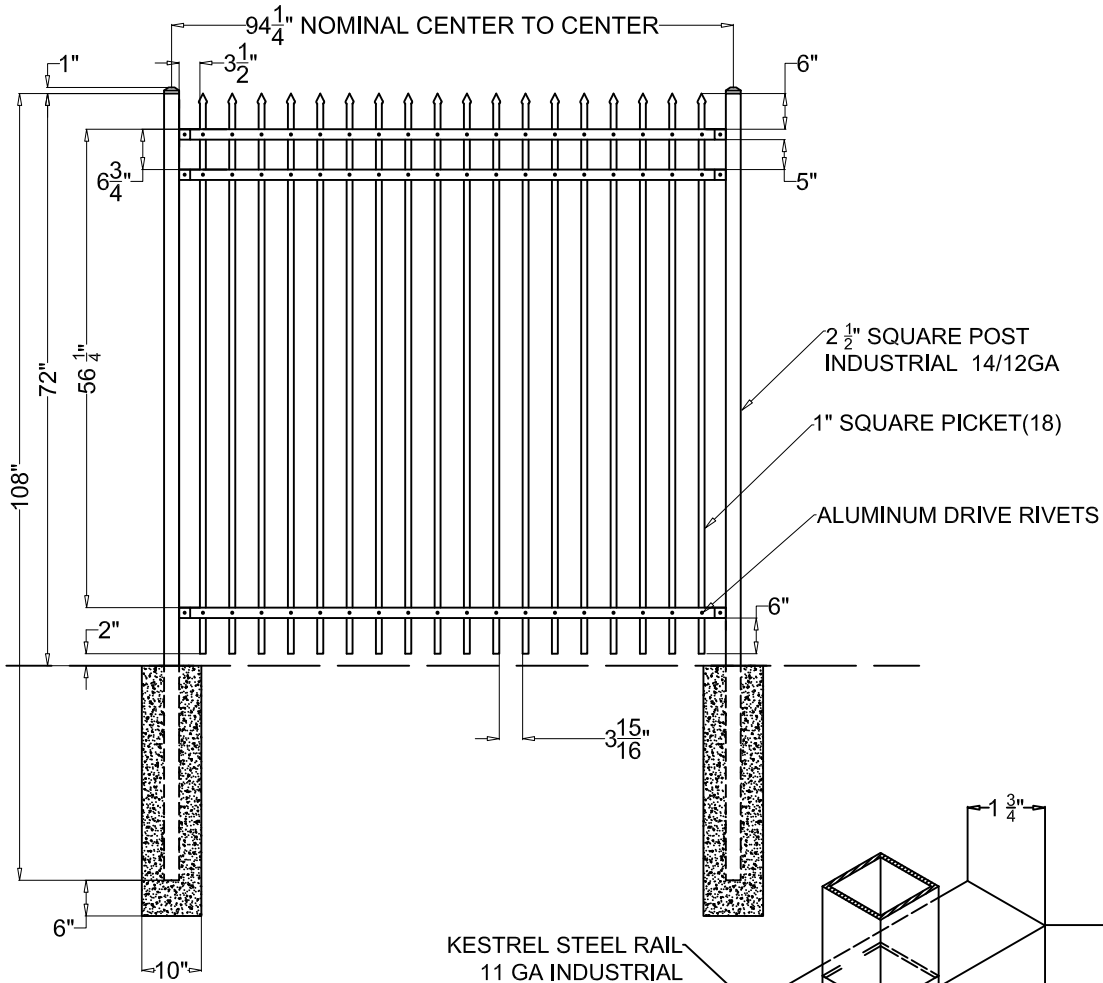
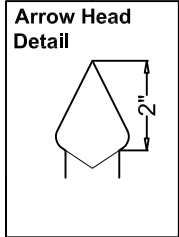

OPTIONS:

Fence Heights:

- 4 ft
- 5 ft
- 6 ft
- 7 ft
- 8 ft

Picket Gauge:

- 18 GAUGE
- 16 GAUGE
- 14 GAUGE

Cap Style:

- Ball Style
- Flat Style

Color:

- Black
- Brown
- White
- Green

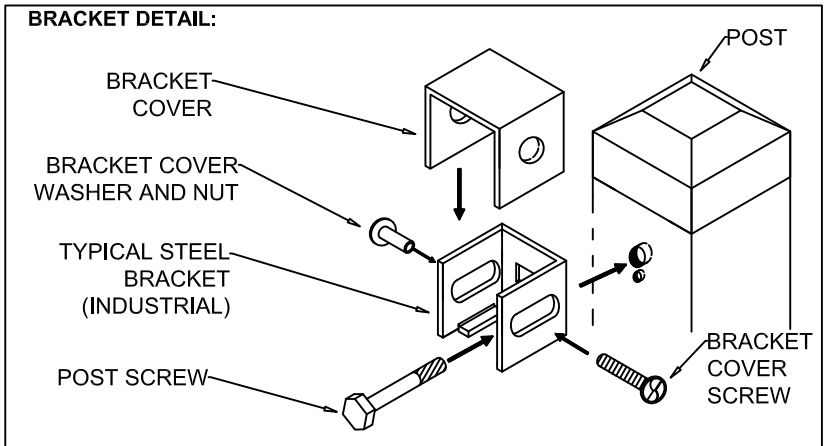
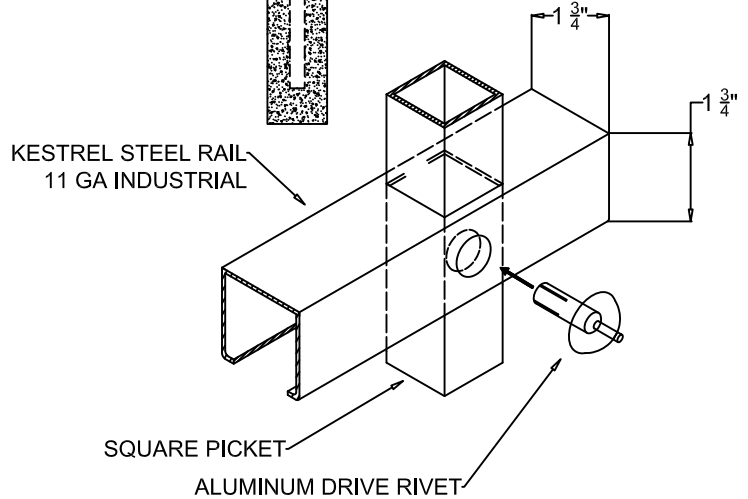

**Kestrel 8' Section
Industrial 6' Height**



NATIONAL FENCE SYSTEMS, INC.
1033 Route 1
Avenel, NJ 07001
1-800-211-2444
www.nationalfencesystems.com

Installer:	DWG NO: KSI.FS8.6
Project:	DR: es